



# MAGNA-POWER ELECTRONICS



## PQ SERIES III

*DC Power Supply*

- ▶ 3.3 kW
- ▶ 6.6 kW
- ▶ 10 kW

# RUGGED CURRENT FED TECHNOLOGY

## HIGH EFFICIENCY OPERATION

### INNOVATIVE

Magna-Power Electronics' **PQ SERIES III** combines the best of dc power processing with multiprocessor embedded control. A combination of high and medium frequency power processing technologies improves response, shrinks package size, and reduces cost. **PQ SERIES III** power supplies are current fed and are more tolerant to abusive loads than conventional switching power supplies.

### SCALABLE POWER

**PQ SERIES III** power supplies offer both master/slave parallel and series operation. This enables two or more power supplies to be placed in parallel for increased output current or in series for increased output voltage. With master/slave operation, power supplies operate at near equal voltage and current.

**PQ SERIES III** power supplies can operate as a voltage source or current source depending on the control settings and load conditions. If the power supply is operating as a voltage source and the load increases to a point beyond the current command setting, the power supply automatically crosses over to current mode control and operates as a current source at that setting.

### UNPARALLELED CONTROL

**PQ SERIES III** power supplies can be configured through the front panel for different applications. The power supply can be programmed to have its control functions accessible from the front panel, rear connector, or through RS232 communications. Sensing can be established at the output terminal of the power supply or through a rear terminal block for sensing at the load. A smart remote sense detector checks whether or not sense leads are present eliminating the potential of uncontrolled operation. An external interlock can be set to enable operation only when an external connection is made. Even calibration has been simplified with front panel access to calibration digital potentiometers.

**PQ SERIES III** power supplies incorporate an optically isolated feedback system. The result is that all user interface circuitry is referenced to earth ground -- not the negative terminal of the power supply. This enables users to connect external circuitry without concern of ground loops or voltage breakdown.

### LOAD DEPENDENT AIR OR OPTIONAL WATER COOLING

**PQ SERIES III** power supplies are designed to operate at rated load 24 hours per day. Standard air cooled units are equipped with variable speed, load dependent blowers to maintain comfortable margins for removing heat from sensitive power semiconductors. Variable speed operation maximizes fan life and a minimizes external environmental hazards.

Optional water cooled models contain integrated semiconductor chillers and air to water heat exchangers to manage cooling of heat producing components. This option allows the power supply to be sealed from the environment enabling placement in harsh environments. These units provide long life in plating facilities, electroplating treatment plants, shipboard, and other corrosive environments. Water cooling also permits power supplies to be stacked in high density equipment racks where air cooling is not possible or desirable.

### FEATURES:

- 54 Models: 5 to 1000 Vdc, 3 to 900 Adc
- Series and parallel master/slave operation
- High dielectric withstand: 2500 Vac
- 50 Hz to 400 Hz input frequency
- All user interface circuitry referenced to earth ground
- OVT and OCT shutdown standard
- Automatic V/I crossover
- RS232 interface with SCPI commands
- Optional IEEE-488 or Ethernet programming
- Front panel potentiometers for stepless rotary control
- Front panel calibration
- User friendly controls and indicators
- Remote Interface Software with self-teaching features
- Drivers: Certified LabWindows/CVI and LabVIEW for GPIB, Serial, and TCP/IP communications
- Load dependent air or option water cooling
- High power factor
- CE Mark



**MAGNA-POWER ELECTRONICS, INC.**

39 Royal Road  
Flemington, NJ

Ph: (908) 237-2200  
Fax: (908) 237-2201

Email: [sales@magna-power.com](mailto:sales@magna-power.com)  
<http://www.magna-power.com>

# MULTIPROCESSOR EMBEDDED CONTROL

## ENHANCED CONTROLS AND DIAGNOSTICS

### ATTENTION TO POWER QUALITY

PQ SERIES III power supplies contain circuitry to work harmoniously with other power equipment. Step-start contactors are used to keep inrush current below full scale operating current. Filter components lower current harmonic content emanating from the power supply and increase power factor to levels beyond 90%. Every power supply is tested at 90 to 125% nominal line to insure satisfactory operation even under the worst line voltage conditions

### DESIGNED FOR SAFETY

PQ SERIES III power supplies have extensive diagnostic functions -- all of which, when activated, take command to shut down the system. Diagnostic functions include phase loss, excessive thermal conditions, over voltage trip, over current trip, fuse clearing, and program line. Program line monitors externally applied analog set point signals to insure they are within the specified range. Upon a diagnostic fault condition, main power is disconnected and the diagnostic condition is latched into memory. Pressing the clear key clears the memory. All diagnostic functions can be monitored through a rear connector. Furthermore, control functions can also be set through the rear connector to allow simultaneous control of one or more PQ SERIES III units.

PQ SERIES III supplies have three levels of over voltage/current protection: shutdown of controlling insulated gate bipolar transistors (IGBT's), disconnect of main power, and input fuses. After an over voltage/current trip condition, the supply must be reset.

PQ SERIES III power supplies have push button start/stop controls. These controls are tied to a mechanical contactor which operates with the electronic switches to break the ac mains when stop is commanded. Unlike competing products, an off means both an electrical and mechanical break in the power circuit — not a break in an electronic switch. Safety comes first at Magna-Power Electronics.

### REMOTE INTERFACE SOFTWARE INCLUDED WITH ALL MODELS

The Remote Interface Software is shipped with PQ SERIES III power supplies. The software provides the user with a quick method to operate a Magna-Power Electronics' power supply under computer control. The Remote Interface Software has six windows: the Virtual Control Panel, Command Panel, Register Panel, Calibration Panel, Firmware Panel, and Modulation Panel. The Virtual Control Panel emulates the front panel of the PQ

SERIES III power supply, the Command

panel programs and reads SCPI commands with user friendly buttons, the Register Panel programs and reads registers, the Calibration Panel enables calibration of the digital potentiometers, the Firmware Panel enables the program stored internal to the power supply to be upgraded, and the Modulation Panel eases program-

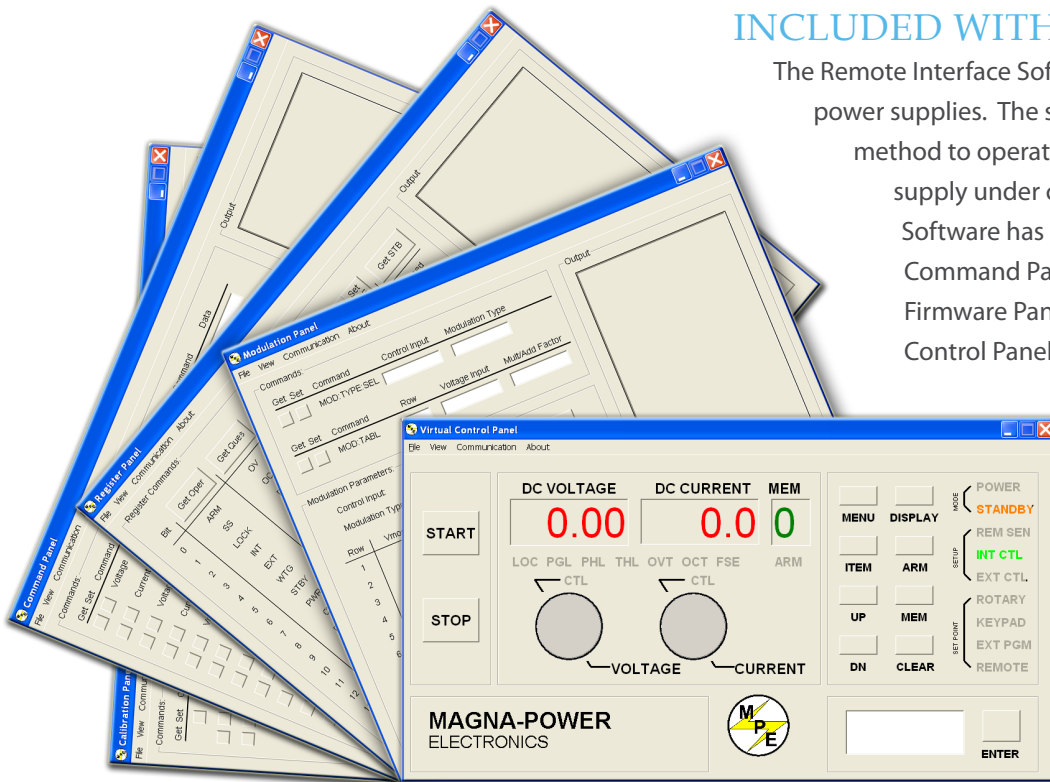

**MAGNA-POWER ELECTRONICS, INC.**

39 Royal Road  
Flemington, NJ

Ph: (908) 237-2200  
Fax: (908) 237-2201

Email: [sales@magna-power.com](mailto:sales@magna-power.com)  
<http://www.magna-power.com>

# THREE CONTROL PANEL OPTIONS

## FOR VARIOUS APPLICATIONS

FEATURES	MODELS		
	PQC	PQA	PQD
<b>FRONT PANEL CONTROLS</b>			
Power on/off	•	•	•
Start/Stop		•	•
Rotary Voltage/Current Entry		•	•
Rotary OVT/OCT Entry		•	
Menu/Item		•	•
Display Settings		•	•
Enter/Clear		•	•
Keypad Voltage/Current Entry			•
Keypad OVT/OCT Entry			•
Arm			•
<b>INDICATORS</b>			
Voltage/Current Set Point		•	•
OVT/OCT Set Point		•	•
Voltage/Current Output		•	•
Internal/External Control		•	•
Alarms		•	•
Rotary/External/Remote Programming		•	•
Remote Sense Enabled		•	•
Keypad Programming			•
Memory Setting			•
Armed for Auto Sequence Operation			•
<b>REAR PANEL CONTROLS</b>			
Voltage/Current Set Point	•	•	•
OVT/OCT Set Point	•	•	•
Modulation Set Point			•
Voltage/Current Output	•	•	•
Internal/External Control	•	•	•
Alarm Outputs (9 lines)	•	•	•
Status Outputs (6 lines)	•	•	•
Master/Slave Connections	•	•	•
Remote Sense Inputs	•	•	•
RS232 Inputs	•	•	•
Interlock Enable	•	•	•
Arm Enable			•

### ANALOG CONTROL A SERIES

**PQ SERIES III** models utilizing the A Version front panel, PQA, provide stepless analog control from front panel potentiometers. With simple configuration changes, voltage, current, over voltage trip, and over current trip may be programmed from the rear connector or by RS232 communications. RS232 communications is embedded in the control circuitry allowing full computer control with SCPI commands. An optional IEEE-488 to RS232 converter, Ethernet to RS232 converter, and other communications converters are available to echo commands over the communications bus. **PQA SERIES** power supplies are well suited for industrial applications requiring a minimum of control.

### DIGITAL CONTROL D SERIES

**PQD SERIES** models have one-hundred memory states available to program voltage, current, over voltage trip, over current trip, and time period. Set points can be auto sequenced with time or external triggering. Special programming codes allow repeating to create a power function generator. The first 10 memory states are displayed on the front panel to simplify programming tasks.

**PQD SERIES** power supplies offer an analog input to modulate the voltage or current setting. This feature enables the voltage or current setting to be adjusted by a sensor input, such as a thermistor, or by monitoring its own voltage or current. Modulation allows the output to be tailored for advanced process control applications, battery charging, and source emulation.

### COMPUTER CONTROL C SERIES

**PQ SERIES III** models utilizing the C Version front panel, PQC, only allow control from the rear connector or by RS232 communications. These models are intended for process control applications where front panel controls and displays are not required or desired.



**MAGNA-POWER ELECTRONICS, INC.**

39 Royal Road  
Flemington, NJ

Ph: (908) 237-2200  
Fax: (908) 237-2201

Email: sales@magna-power.com  
<http://www.magna-power.com>



## A SERIES FRONT PANEL

Meters display voltage, current, over voltage protection, over current protection

Switches main power on and off

### MODE AND CONFIGURATION

POWER: Indicates power output  
 STANDBY: Indicates control power only  
 INT CTL: Front panel controls enabled  
 EXT CTL: External controls enabled  
 REM SEN: Indicates remote sense  
 EXT PGM: External voltage/current control  
 ROTARY: Potentiometer voltage/current control  
 REMOTE: RS232 control enabled

### ALARMS

LOCK: Interlock  
 PGM LINE: External input beyond limits  
 OVT: Shows over voltage protection has tripped  
 OCT: Show over current protection has tripped  
 FUSE: Warns that a fuse has cleared  
 THERM: Indicates overheating  
 PHASE: Indicates a problem with the input voltage

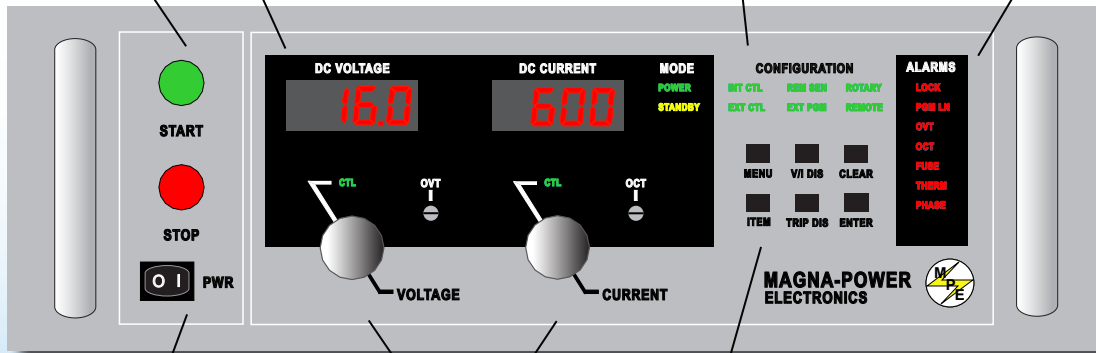

Energizes control circuits without turning the main power on

Sets voltage and current in rotary mode

### FUNCTION KEYS

MENU: Select function  
 V/I DIS: Displays voltage and current setting  
 CLEAR: Clear setting or reset fault condition

ITEM: Select item within function  
 TRIP DIS: Displays OVT and OCT setting  
 ENTER: Enter Setting

## D SERIES FRONT PANEL

### ALARMS

LOC: Interlock  
 PGL: Warn that a program line has opened  
 PHL: External input beyond limits  
 THL: Indicates over-temperature  
 OVT: Shows over voltage protection has tripped

OCT: Show over current protection has tripped  
 FSE: Warns that a fuse has cleared  
 ARM: Indicates power supply is ready for or operating in auto sequencing

### MODE AND CONFIGURATION

POWER: Indicates power output  
 STANDBY: Indicates control power only  
 REM SEN: Indicates remote sense  
 INT CTL: Front panel controls enabled

EXT CTL: External controls enabled  
 ROTARY: Potentiometer voltage/current control  
 KEYPAD: Keypad voltage/current control  
 EXT PGM: External voltage/current control  
 REMOTE: RS232 control enabled

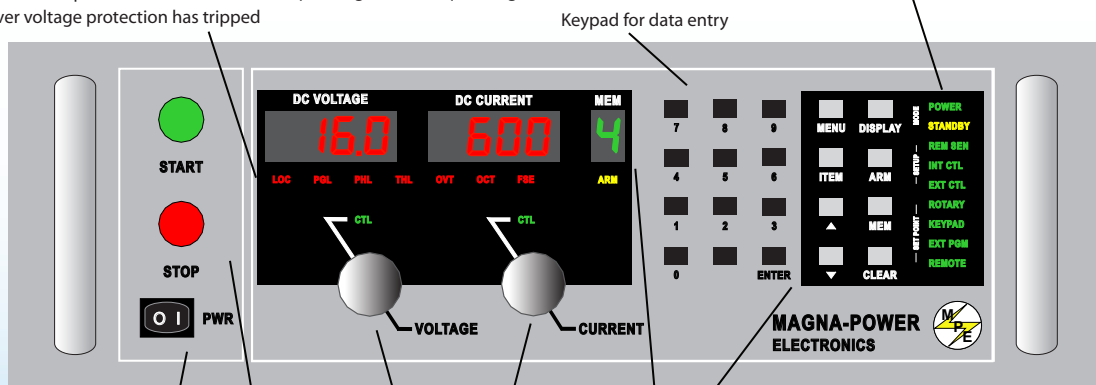

Energizes control circuits without turning the main power on

Switches main power on and off

Sets voltage and current in rotary mode

Meters display voltage, current, over voltage protection, over current protection

Keypad for data entry

### FUNCTION KEYS

MENU: Select function  
 DISPLAY: Displays voltage and current setting  
 ITEM: Select item within function  
 CLEAR: Clears setting or reset fault conditions

ARM: arms power supply for auto sequencing through styes stored in memory

MEM: Sets memory  
 ▲ : Up  
 ▼ : Down

## C SERIES FRONT PANEL



Energizes control circuits without turning the main power on

# MODELS AND RATINGS

3.3 kW MODELS	VOLTS (Vdc)	AMPS (Adc)	RIPPLE (mVrms)
PQ5-600	0-5	0-600	50
PQ8-400	0-8	0-400	40
PQ10-300	0-10	0-300	40
PQ16-200	0-16	0-200	35
PQ20-165	0-20	0-165	40
PQ32-100	0-32	0-100	40
PQ40-82	0-40	0-82	40
PQ50-65	0-50	0-65	50
PQ80-41	0-80	0-41	60
PQ100-33	0-100	0-33	60
PQ125-26	0-125	0-26	100
PQ160-20	0-160	0-20	120
PQ200-16	0-200	0-16	125
PQ250-13	0-250	0-13	130
PQ375-8	0-375	0-8	170
PQ500-6	0-500	0-6	220
PQ600-5	0-600	0-5	250
PQ800-4	0-800	0-4	300
PQ1000-3	0-1000	0-3	350

6.6 kW MODELS	VOLTS (Vdc)	AMPS (Adc)	RIPPLE (mVrms)
PQ8-800	0-8	0-800	40
PQ10-600	0-10	0-600	40
PQ16-400	0-16	0-400	35
PQ20-330	0-20	0-330	40
PQ32-200	0-32	0-200	40
PQ40-165	0-40	0-165	40
PQ50-130	0-50	0-130	50
PQ80-82	0-80	0-82	60
PQ100-66	0-100	0-66	60
PQ125-53	0-125	0-53	100
PQ160-41	0-160	0-41	120
PQ200-33	0-200	0-33	125
PQ250-26	0-250	0-26	130
PQ375-17	0-375	0-17	170
PQ500-13	0-500	0-13	220
PQ600-10	0-600	0-10	250
PQ800-8	0-800	0-8	300
PQ1000-6	0-1000	0-6	350

10 kW MODELS	VOLTS (Vdc)	AMPS (Adc)	RIPPLE (mVrms)
PQ10-900	0-10	0-900	40
PQ16-600	0-16	0-600	35
PQ20-500	0-20	0-500	40
PQ32-300	0-32	0-300	40
PQ40-250	0-40	0-250	40
PQ50-200	0-50	0-200	50
PQ80-125	0-80	0-125	60
PQ100-100	0-100	0-100	60
PQ125-80	0-125	0-80	100
PQ160-62	0-160	0-62	120
PQ200-50	0-200	0-50	125
PQ250-40	0-250	0-40	130
PQ375-27	0-375	0-27	170
PQ500-20	0-500	0-20	220
PQ600-16	0-600	0-16	250
PQ800-12	0-800	0-12	300
PQ1000-10	0-1000	0-10	350

## MODEL ORDERING SYSTEM

SERIES NAME	FRONT PANEL	VO DC	IO DC	INPUT VOLTAGE
PQ TS MS MT	A: Analog D: Digital C: Computer	See Tables	See Tables	240 SP 208 240 380 415 440 480
<i>Example: PQD32-200/208</i>				
PQ	D	32	200	240

**Options:**  
Custom output voltage  
IEEE-488 Interface

Ethernet Interface  
USB Interface  
EMI Filter

### Notes:

- Specifications are subject to change without notice
- Specify optional EMI filter to meet EMC requirements
- For other options, consult factory

## SPECIFICATIONS:

**Input Voltage:**

- 240 Vac, 50-60 Hz, 1φ (3.3 kW only)
- 208/240 Vac, 50-400 Hz, 3φ
- 380/415 Vac, 50-400 Hz, 3φ
- 440/480 Vac, 50-400 Hz, 3φ

**Line Regulation:**

- Voltage Mode: ±.004% of full scale
- Current Mode: ±.02% of full scale

**Load Regulation:**

- Voltage Mode: ±.01% of full scale
- Current Mode: ±.04% of full scale

**Stability:** ± 0.10% for 8 hrs. after 30 min. warmup

**Isolation:**

- Maximum input voltage to ground: ±2500 Vac
- Maximum output voltage to ground: ±1000 Vdc
- User inputs and outputs: referenced to earth ground

**Power Factor:** greater than 92% at maximum power.

**Ambient Temperature:** 0°C to 50°C

**Storage Temperature:** -25°C to +85°C

**Temperature Coefficient:** 0.04/°C of max. output current

### Water Cooling:

- 25°C maximum inlet temperature
- 1.5 GPM minimum flow rate
- 80 PSI maximum pressure
- 1/4" NPT female pipe size

**Efficiency:** ≥ 86%

### Size (H" x W" x D") and Weight:

- **3.3 kW Model:** 5¼" H x 19" W x 24" D at 74 lbs
- **6.6 kW Model:** 5¼" H x 19" W x 24" D at 97 lbs
- **10 kW Model:** 5¼" H x 19" W x 24" D at 125 lbs

**Load Transient Response:** 2 ms to recover within ±1% of regulated output with a 50% to 100% or 100% to 50% step load change

### Remote sense limits:

- 3% maximum voltage drop from output terminals to load

### Remote analog programming limits:

- Voltage set point: 0-2.0 Vdc
- Current set point: 0-2.0 Vdc
- Over voltage trip set point: 0 to 2.2 Vdc
- Over current trip set point: 0 to 2.2 Vdc
- Modulation: 0 to 2.0 Vdc (D Version models only)

### Remote analog programming accuracy of full scale:

- Voltage set point: ±.50%
- Current set point: ±.75%
- Over voltage trip set point: ±.50%
- Over current trip set point: ±.75%

### Analog monitoring accuracy of full scale:

- Output voltage: ±.50%
- Output current: ±.75%

### Digital programming accuracy of full scale:

- Voltage set point: ±.50%
- Current set point: ±.75%
- Over voltage trip set point: ±.50%
- Over current trip set point: ±.75%

### Digital readback accuracy of full scale:

- Output voltage: ±.50%
- Output current: ±.75%

### Period programming limits:

- Minimum period: 10 msec
- Maximum period: 9997 sec or 2.77 hours

### Digital control inputs and outputs limits:

- Input voltage: 0 to 5 Vdc
- Output voltages: 0 to 5 Vdc, 5 mA drive capacity per line
- 5 V supply: 25 mA

# SPECIAL APPLICATIONS

## FOR D SERIES FRONT PANEL

### POWER WAVEFORM GENERATOR

PQD SERIES power supplies can be programmed to operate as a power waveform generator. Each memory state needs to be programmed for the desired voltage or current for a specific time period. An example of a power waveform generator is exemplified by the figure on the right. In this particular example, the voltage set point is changed in 10 second intervals while the current, over voltage trip, and over current trip are kept constant. To make the power supply repeat the voltage ramp, a time period of 9998 is entered for step 9. The programming causes the memory state to jump back to 0 after completing step 8.

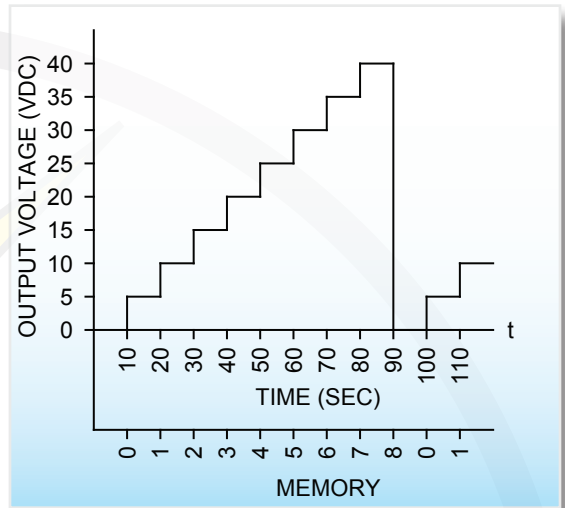

Sawtooth output voltage

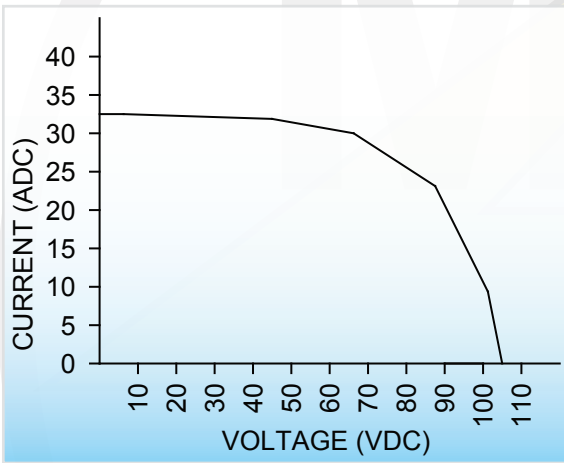

IV characteristics for a typical photovoltaic array

### PHOTOVOLTAIC CELL SIMULATOR

Modulation enables the power supply to emulate different sources: such as batteries, fuel cells, photovoltaic arrays, etc. To simulate a photovoltaic array, connect terminal 24 of JS1 to terminal 25 of JS1, set the modulation control parameter to voltage control, and set the modulation type to 0. The figure on the left illustrates the programmed piece-wise linear approximation for a typical photovoltaic array.

### BATTERY CHARGER

The figure on the right illustrates a temperature compensated battery charger for applications with lead acid batteries. Diode D1, placed between the power supply and battery, blocks current from flowing from the battery to the power supply. This eliminates any loading on the battery when the power supply is off, but more importantly, prevents the battery from charging the power supply's output capacitors. With deployment of diode D1, remote sensing should be applied across the battery terminals to compensate for the diode drop. By setting the voltage and current to the bulk charge voltage and maximum charge current, the power supply will initially charge the batteries in current mode control and then automatically crossover to voltage mode control when the batteries reach the desired set point. The power supply can be programmed for time dependent, sequential step operation to equalize and float charge the batteries after bulk charging. Equalization is generally not required for every charge cycle.

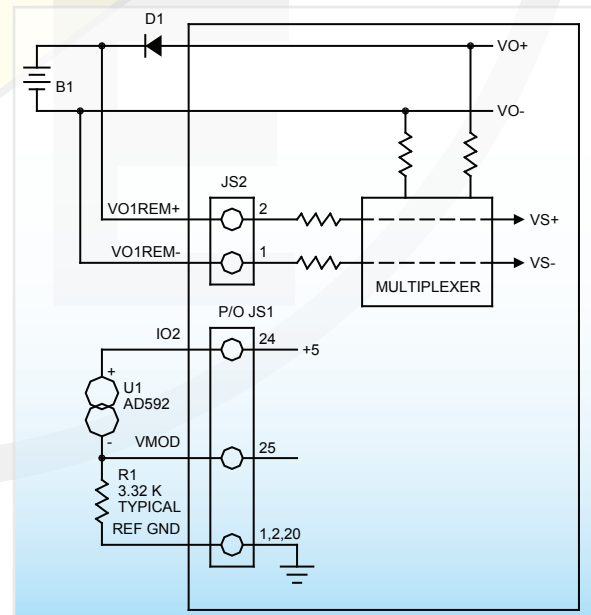

**MAGNA-POWER ELECTRONICS, INC.**

39 Royal Road  
Flemington, NJ

Ph: (908) 237-2200  
Fax: (908) 237-2201

Email: [sales@magna-power.com](mailto:sales@magna-power.com)  
<http://www.magna-power.com>

# AIR COOLED MODELS

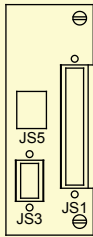

OPTIONAL ETHERNET INTERFACE

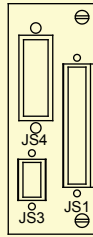

OPTIONAL IEEE-488 INTERFACE

## CONNECTOR JS2

TERM	PARAMETER
1	VO1REM-
2	VO1REM+

## CONNECTOR JS3

TERM	PARAMETER
1	NC
2	RX
3	TX
4	DTR
5	GND
6	DSR
7	RTS
8	CTS
9	NC

## CONNECTOR JS1

TERM	PARAMETER	TERM	PARAMETER
1	REF GND	20	REF GND
2	REF GND	21	REF
3	VREF EXT	22	IREF EXT
4	TVREF EXT	23	TIREF EXT
5	VO2	24	IO2
6	REF CAL	25	VMOD
7	GND	26	+5
8	POWER	27	PGM LINE
9	THERMAL	28	STANDBY
10	INTERLOCK	29	PHASE LOSS
11	CUR CTL	30	VOLT CTL
12	STANDBY/ALM	31	RESERVE
13	ALM	32	OCT
14	EXT CTL	33	INT CTL
15	FUSE	34	OVT
16	RESERVE	35	RESERVE
17	START	36	ARM
18	CLEAR	37	INTERLOCK SET
19	STOP		

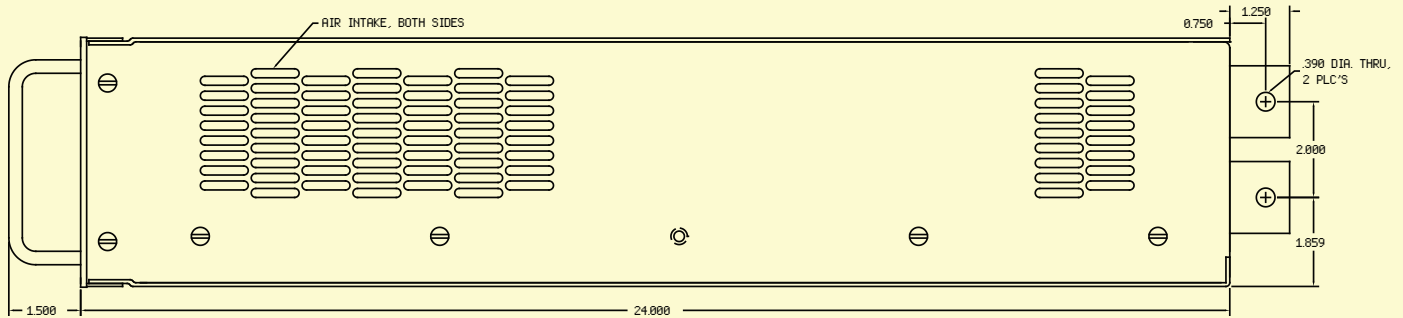
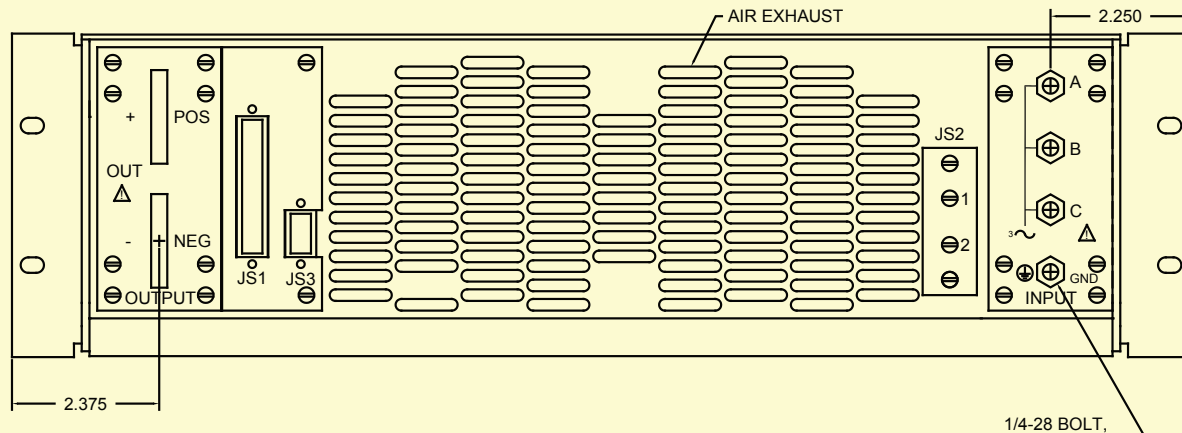
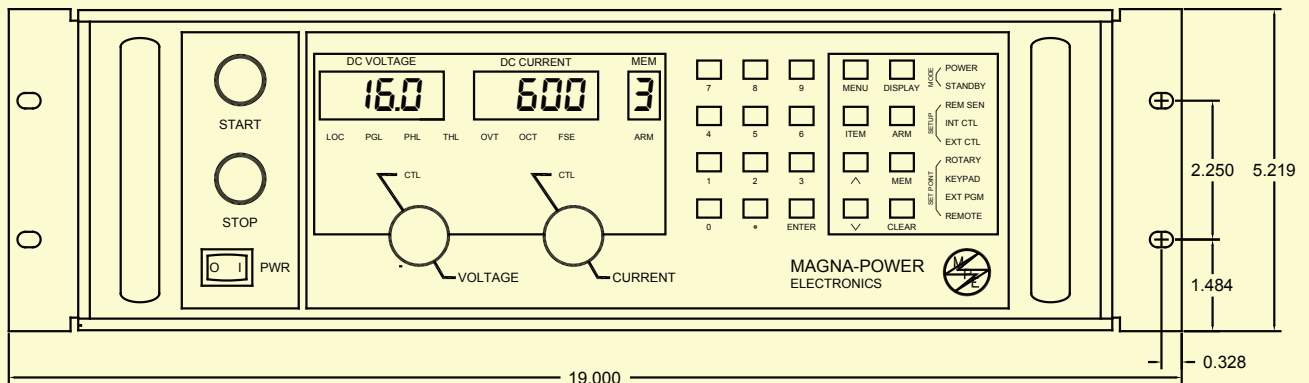

## MAGNA-POWER ELECTRONICS, INC.

39 Royal Road  
Flemington, NJ

Ph: (908) 237-2200  
Fax: (908) 237-2201

Email: sales@magna-power.com  
http://www.magna-power.com



# WATER COOLED MODELS

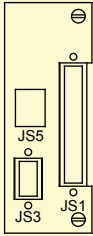

OPTIONAL ETHERNET INTERFACE

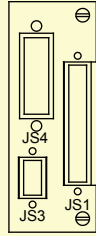

OPTIONAL IEEE-488 INTERFACE

CONNECTOR JS2	
TERM	PARAMETER
1	VO1REM-
2	VO1REM+

CONNECTOR JS3	
TERM	PARAMETER
1	NC
2	RX
3	TX
4	DTR
5	GND
6	DSR
7	RTS
8	CTS
9	NC

CONNECTOR JS1			
TERM	PARAMETER	TERM	PARAMETER
1	REF GND	20	REF GND
2	REF GND	21	REF
3	VREF EXT	22	IREF EXT
4	TVREF EXT	23	TIREF EXT
5	VO2	24	IO2
6	REF CAL	25	VMOD
7	GND	26	+5
8	POWER	27	PGM LINE
9	THERMAL	28	STANDBY
10	INTERLOCK	29	PHASE LOSS
11	CUR CTL	30	VOLT CTL
12	STANDBY/ALM	31	RESERVE
13	ALM	32	OCT
14	EXT CTL	33	INT CTL
15	FUSE	34	OVT
16	RESERVE	35	RESERVE
17	START	36	ARM
18	CLEAR	37	INTERLOCK SET
19	STOP		

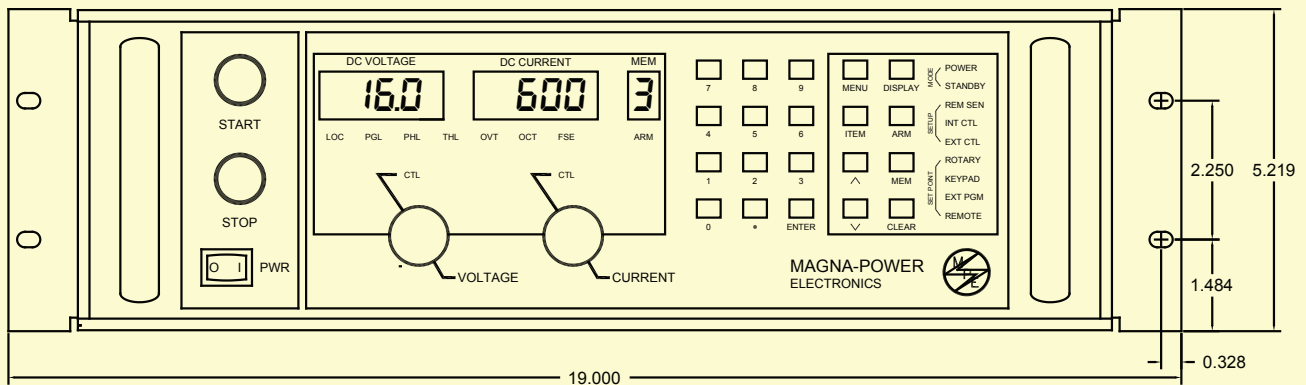

## REAR PANEL

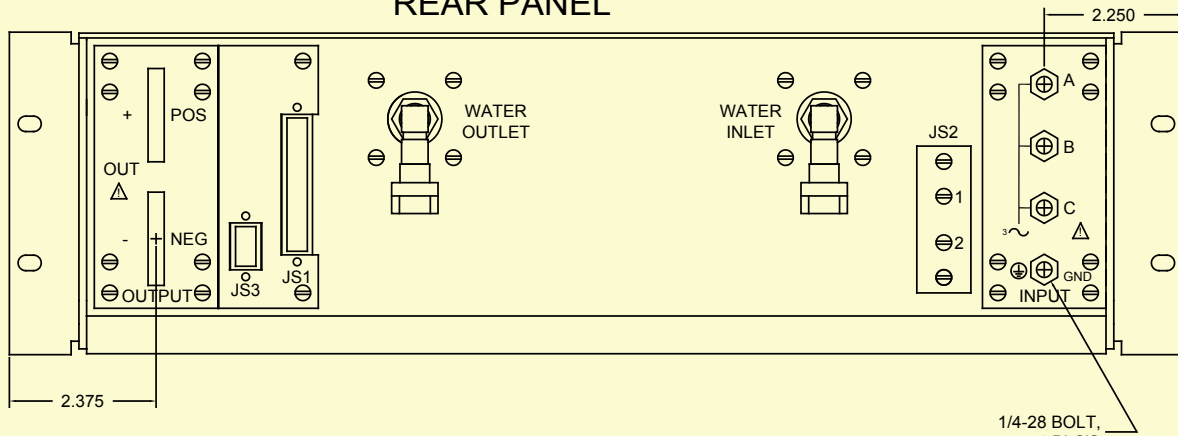

## SIDE PANEL

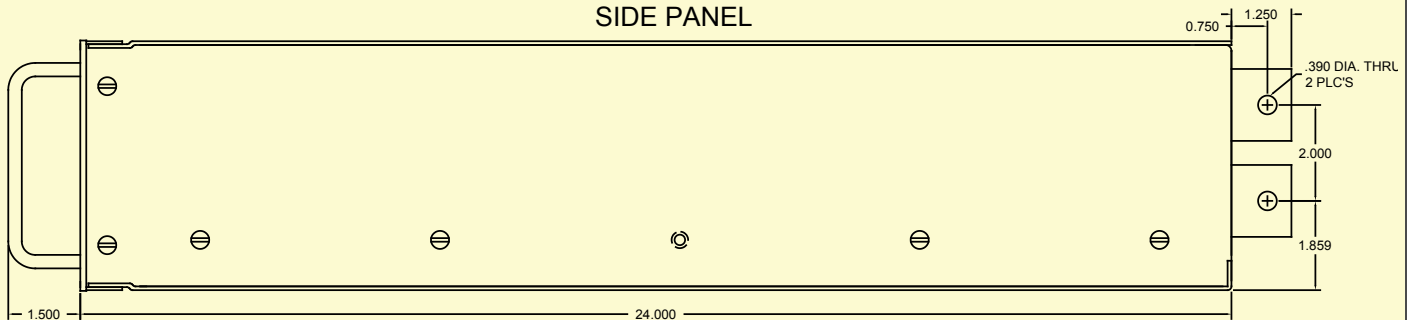

**MAGNA-POWER ELECTRONICS, INC.**

39 Royal Road  
Flemington, NJ

Ph: (908) 237-2200  
Fax: (908) 237-2201

Email: sales@magna-power.com  
http://www.magna-power.com